



greenwaste

ADVENTURES IN RECYCLING

presents:

"COLOR THE EARTH GREEN"



INTRODUCING
**CAPTAIN
GREENWASTE**

illustrated by JAMES BRUNNER

3-2011

AN EDUCATIONAL ACTIVITIES BOOK



PRINTED ON 30% RECYCLED PAPER

DO YOU KNOW THE 3 R'S?

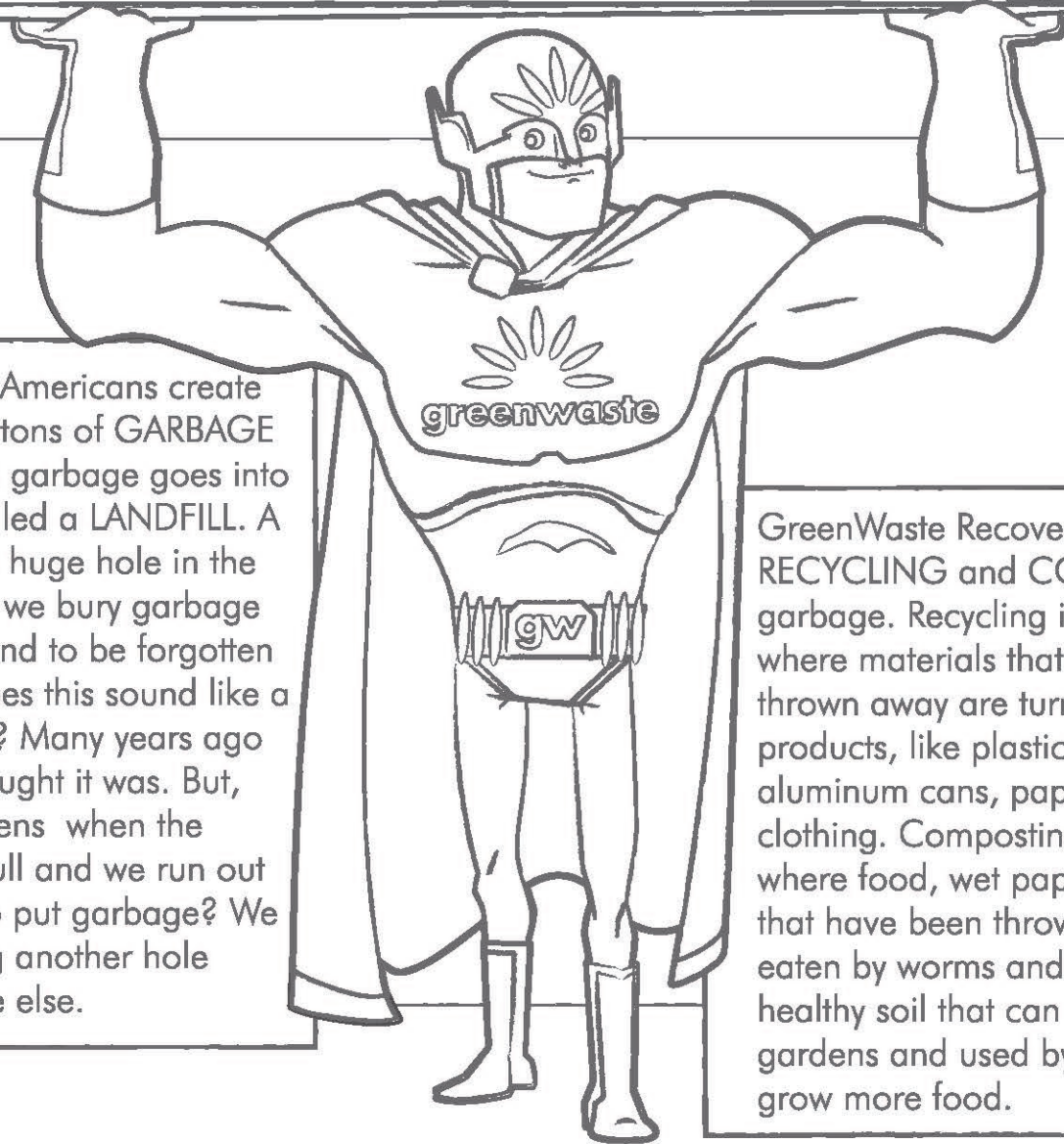

Each year, Americans create millions of tons of GARBAGE and all this garbage goes into a place called a LANDFILL. A landfill is a huge hole in the earth where we bury garbage in the ground to be forgotten forever. Does this sound like a good idea? Many years ago people thought it was. But, what happens when the landfill is full and we run out of space to put garbage? We have to dig another hole somewhere else.

GreenWaste Recovery is helping by RECYCLING and COMPOSTING garbage. Recycling is a process where materials that have been thrown away are turned into new products, like plastic toys, aluminum cans, paper and even clothing. Composting is a process where food, wet paper and plants that have been thrown away are eaten by worms and bugs to create healthy soil that can be added to gardens and used by farmers to grow more food.

Our best solution is to practice the three R's.

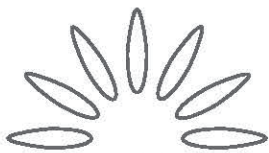

REDUCE

WE SHOULD REDUCE THE AMOUNT OF GARBAGE WE THROW AWAY

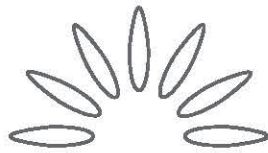

REUSE

WE SHOULD REUSE THE THINGS WE CAN

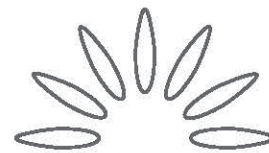

RECYCLE

WE SHOULD RECYCLE AS MANY THINGS AS POSSIBLE

HELP THE DRIVER FINISH HIS ROUTE!

The truck driver needs your help to guide him through the maze so he can take all the materials that he picked up to the GreenWaste Material Recovery Facility, or MRF for short. At the MRF all materials are run through a series of machines and sorting lines to separate all the recyclables from the garbage. Once this is done all the recyclables are shipped off to be given a new life as other products!

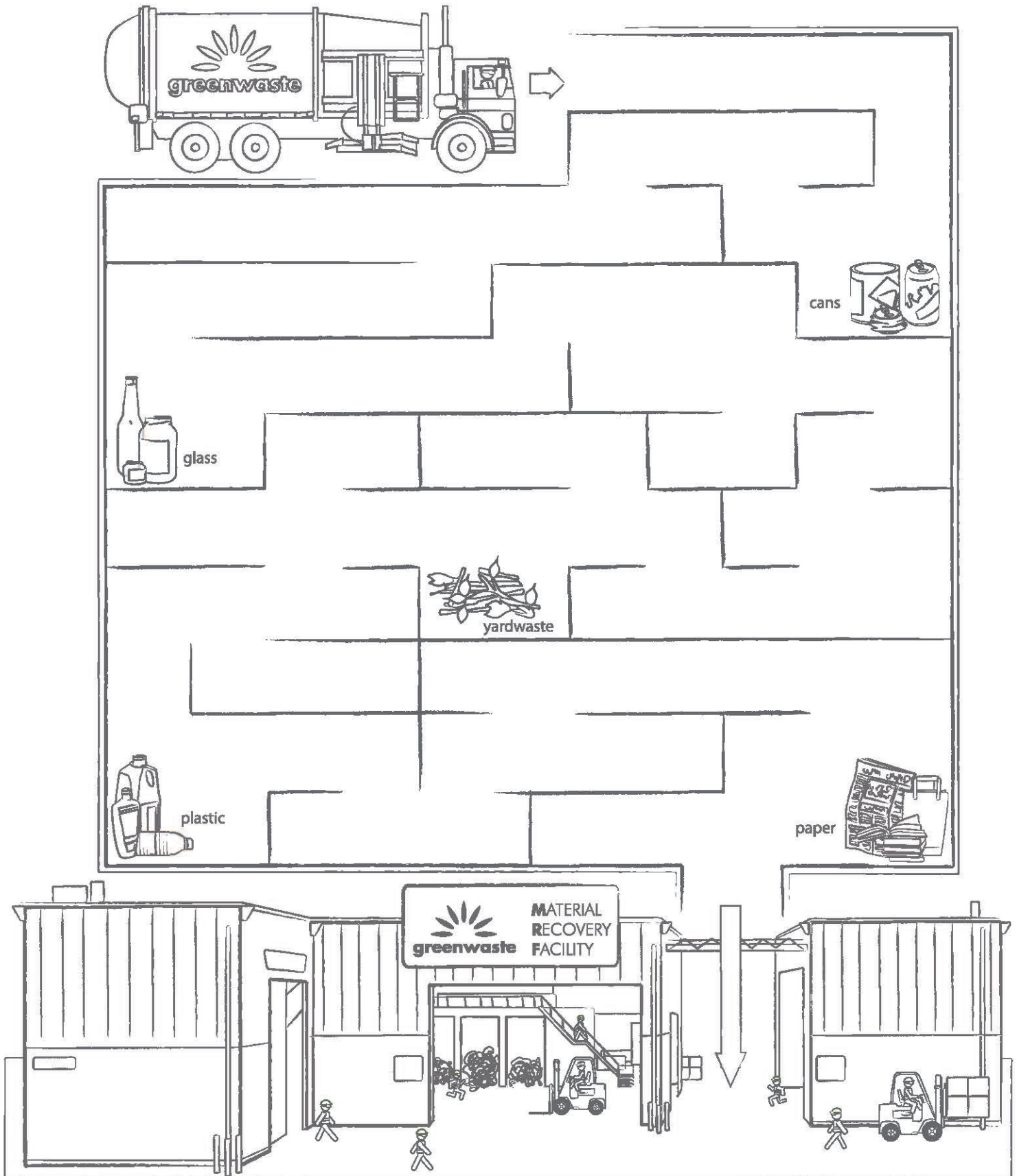

CART

side view

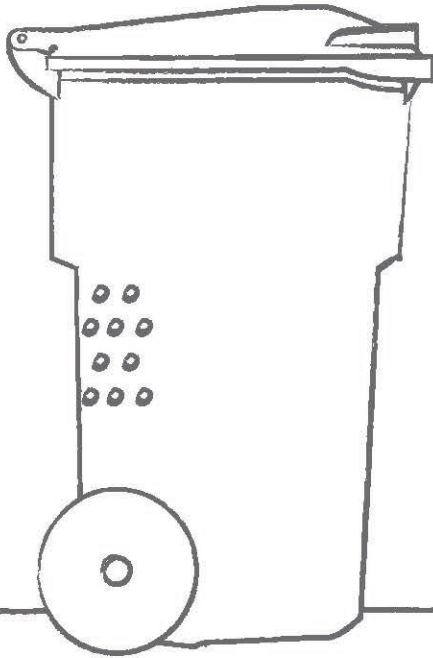

front view

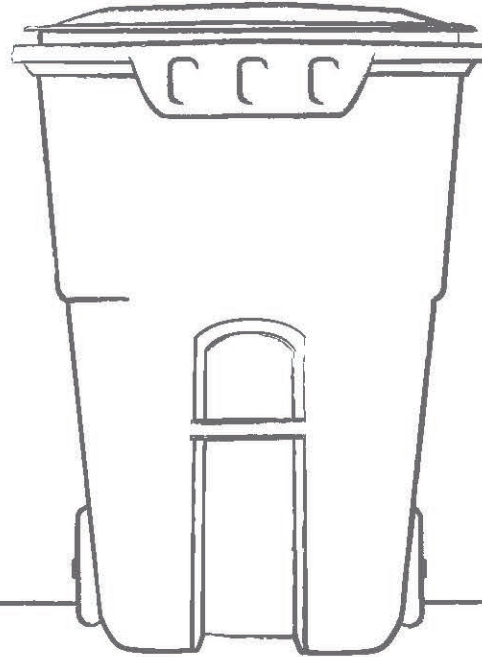

A **cart** is the smallest size collection container and has 2 wheels and a lid. Carts are mostly used at houses. Carts can also be called cans.

SIDE LOADER TRUCK



A **side loader truck** has a grabber arm that reaches out, picks up the carts, and dumps the material into the body of the truck.

BIN

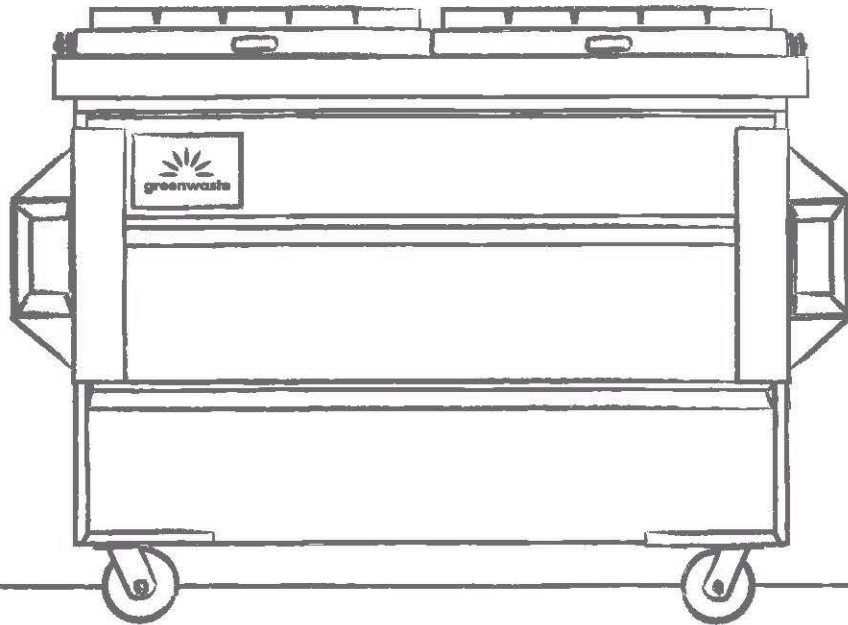

A **bin** is a medium-sized collection container with 4 wheels and a lid that is used at businesses and apartments. Bins can also be called dumpsters.

FRONT LOADER TRUCK



A **front loader truck** has arms that reach forward to pick up the garbage and recycling bins from businesses and apartments.

WORDS TO KNOW SCRAMBLE!

Captain GreenWaste and his side-kick Recovery need your help! The letters of each word are all mixed up. Use the word key and definitions to help guide you to unscramble each word and write out the correct word in the blank spaces below.

D S Y W R A T A E

(Materials consisting of grass, leaves, vines, twigs, and branches)

Y R E L C C E

(To collect used material to make into new products)

T R T E I L

(Material that is thrown on the ground and not placed in a container)

P C M S E O E D O

(To rot or decay)

U E S E R

(To use something again)

O T M P C S O

(A mixture of decomposing organic material, such as food scraps and leaves, that is used to enrich soil).

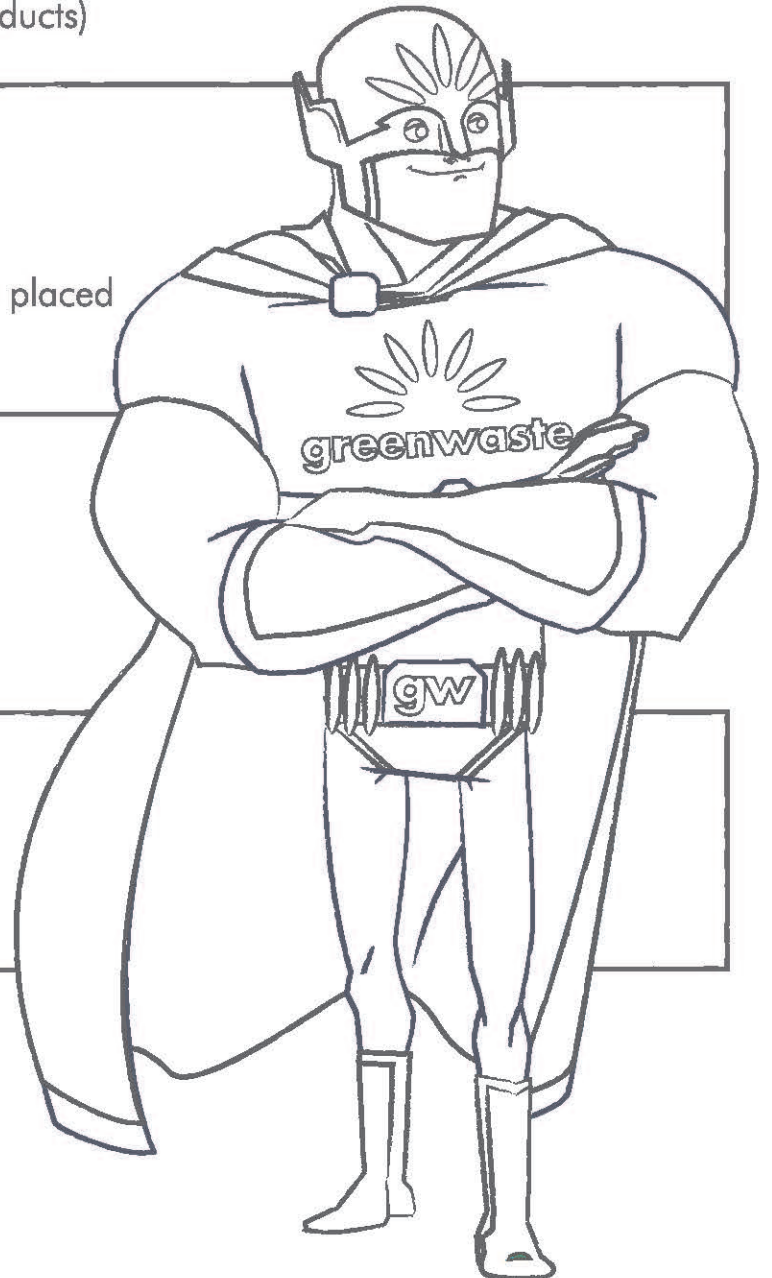

L D F A I L N L

(A place where trash is buried)

U R D E C E

(To decrease the amount of trash you throw away)

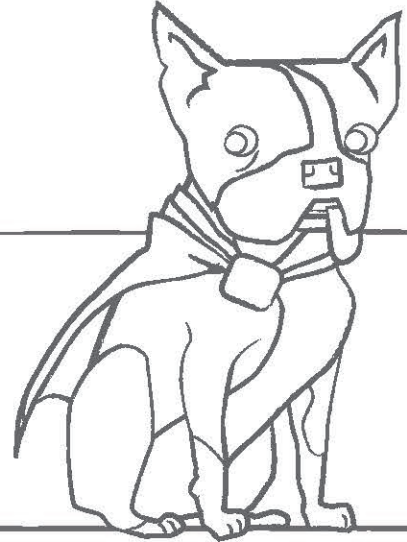

A G R A B E G

(Used, discarded, and unwanted waste material)

I O S L

(A combination of rocks and minerals that is used to help plants grow)

T E P U M S D R

(A large metal trash bin that is used to receive and transport waste)

I O C N A R G

(Material that is, or once was, a plant or animal)

KEYWORDS

- COMPOST • ORGANIC • RECYCLE • GARBAGE • LANDFILL • REDUCE •
- YARDWASTE • SOIL • REUSE • DECOMPOSE • LITTER • DUMPSTER •

CIRCLE THE THINGS THAT GREENWASTE CAN RECYCLE!

Hidden on this page are 6 things that can be recycled or composted. He needs your help! Circle the 3 things that Henry can put into his yard trimmings cart and the 3 things he can put into his recycling cart.



recycling: soda can, cardboard box, water bottle
yard trimmings: tree branch, leaves, flowers

REDUCE YOUR WASTE!

Pack an eco-friendly lunch and join the green bunch! Draw a line from each item in the wasteful lunch to the item in the eco-friendly lunch to learn how you can repack this lunch and reduce your waste!

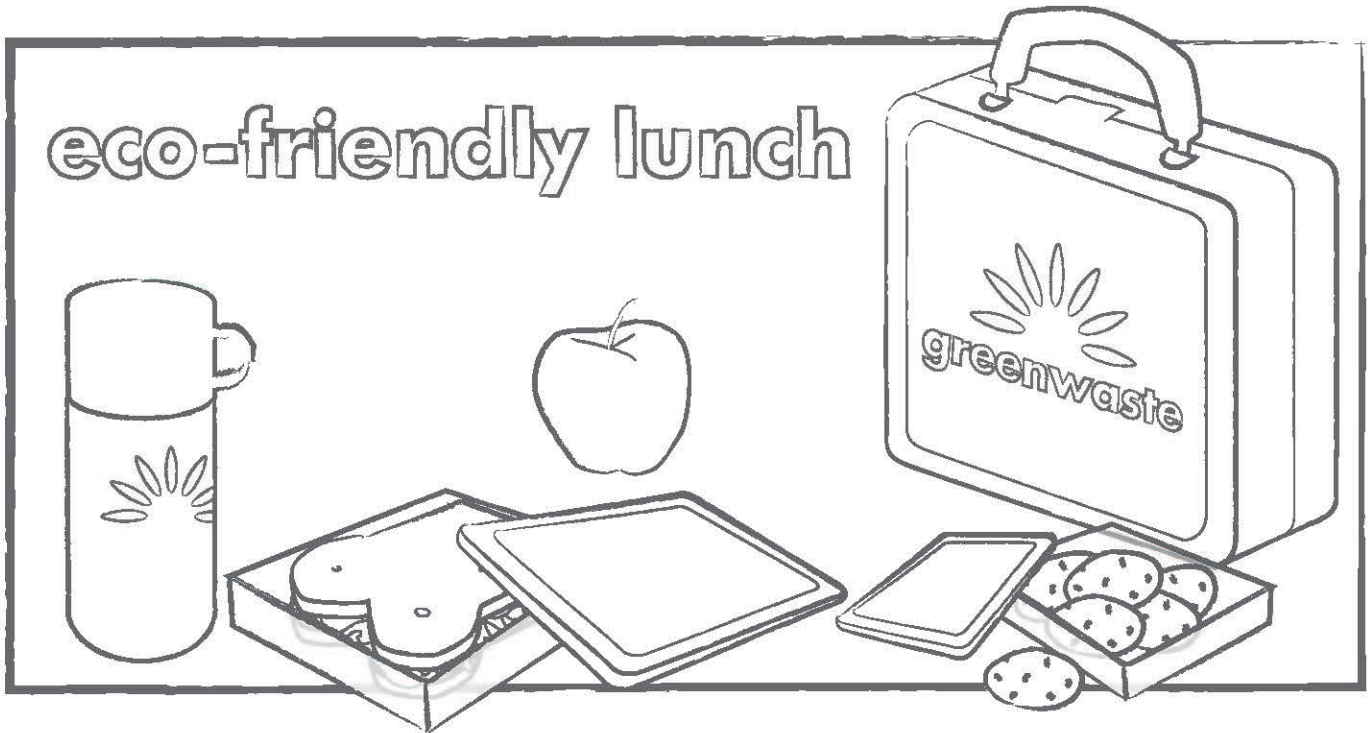
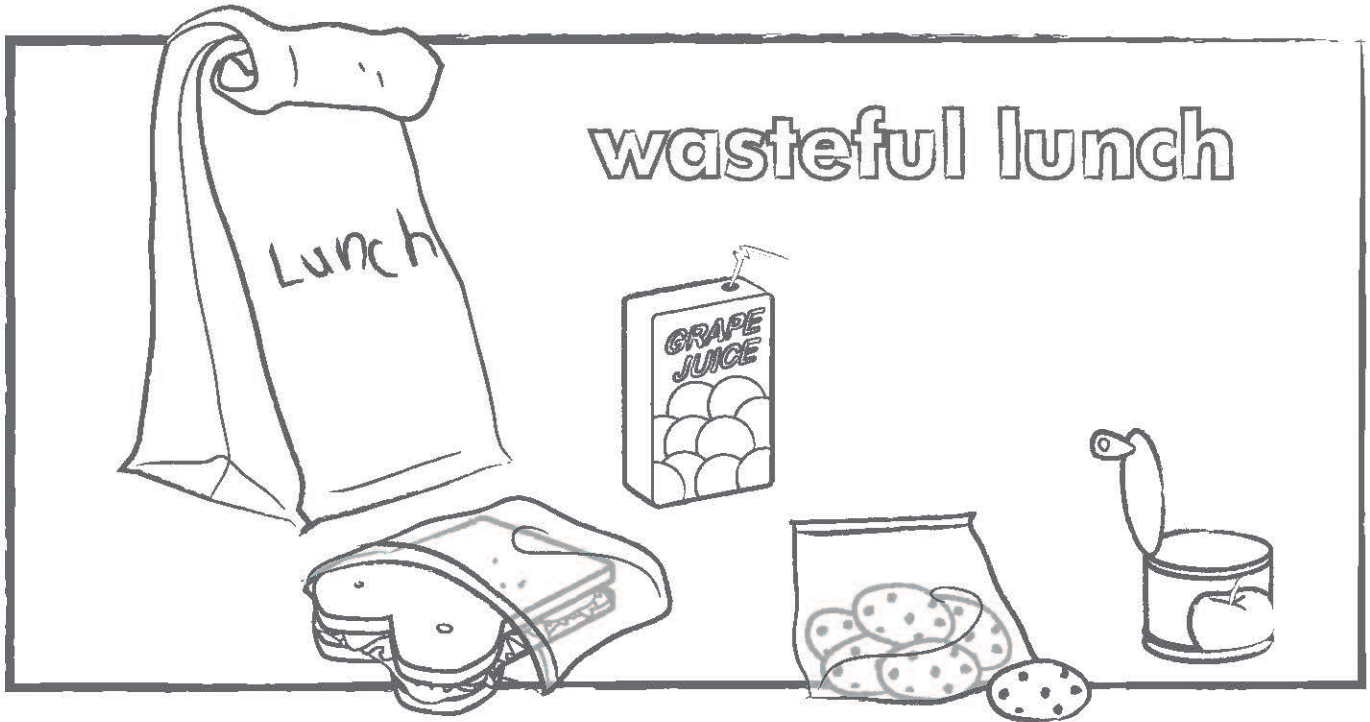

greenwaste
ADVENTURES IN RECYCLING
presents:



CAPTAIN GREENWASTE
in
"RECYCLING REBOUND"

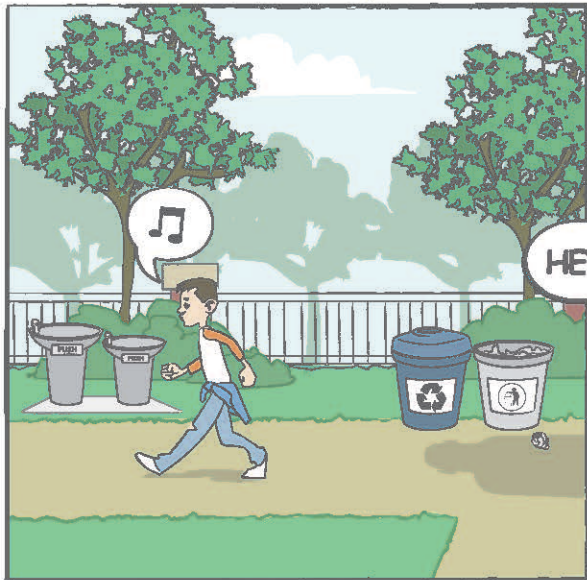
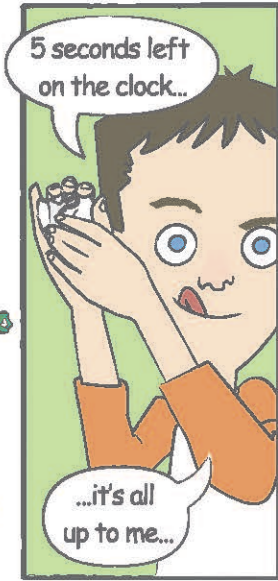

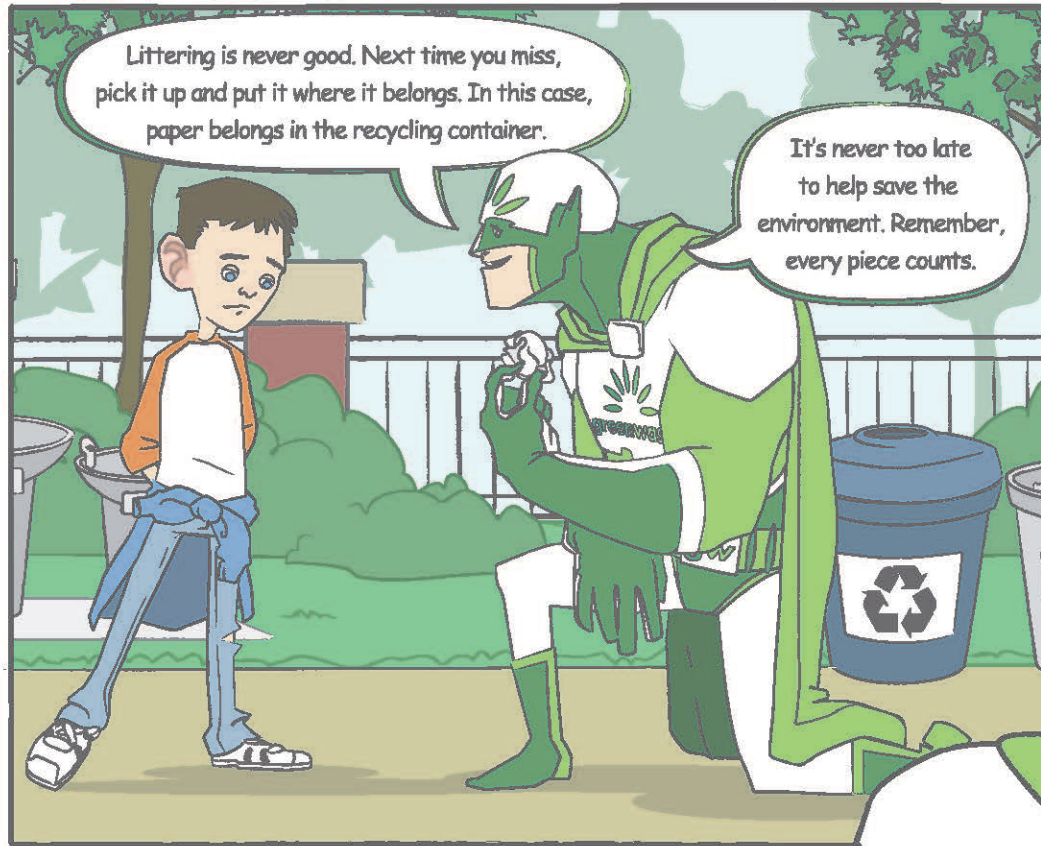
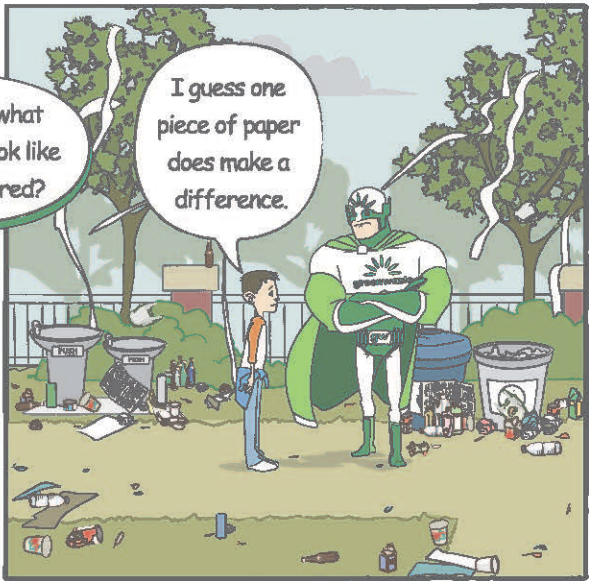

ROLL OFF TRUCK



A **roll off truck** picks up one large box at a time of mixed debris from construction and demolition sites.

STREET SWEEPER

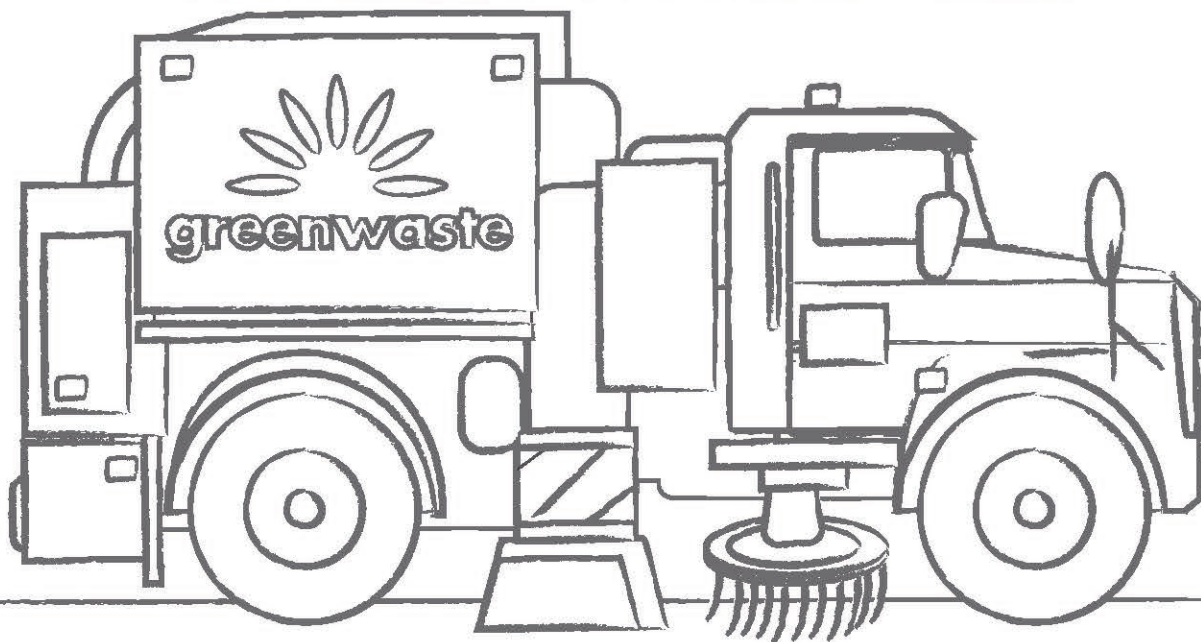

A **street sweeper** comes through neighborhoods and cleans up the streets. Street sweepers have a giant vacuum to collect small debris and particles from the street.

CONNECT THE DOTS!

GreenWaste Recovery uses special equipment to complete all the different types of equipment to collect garbage and recycling. Connect the dots to reveal what piece of machinery GreenWaste uses to collect all the garbage and recycling from your home.

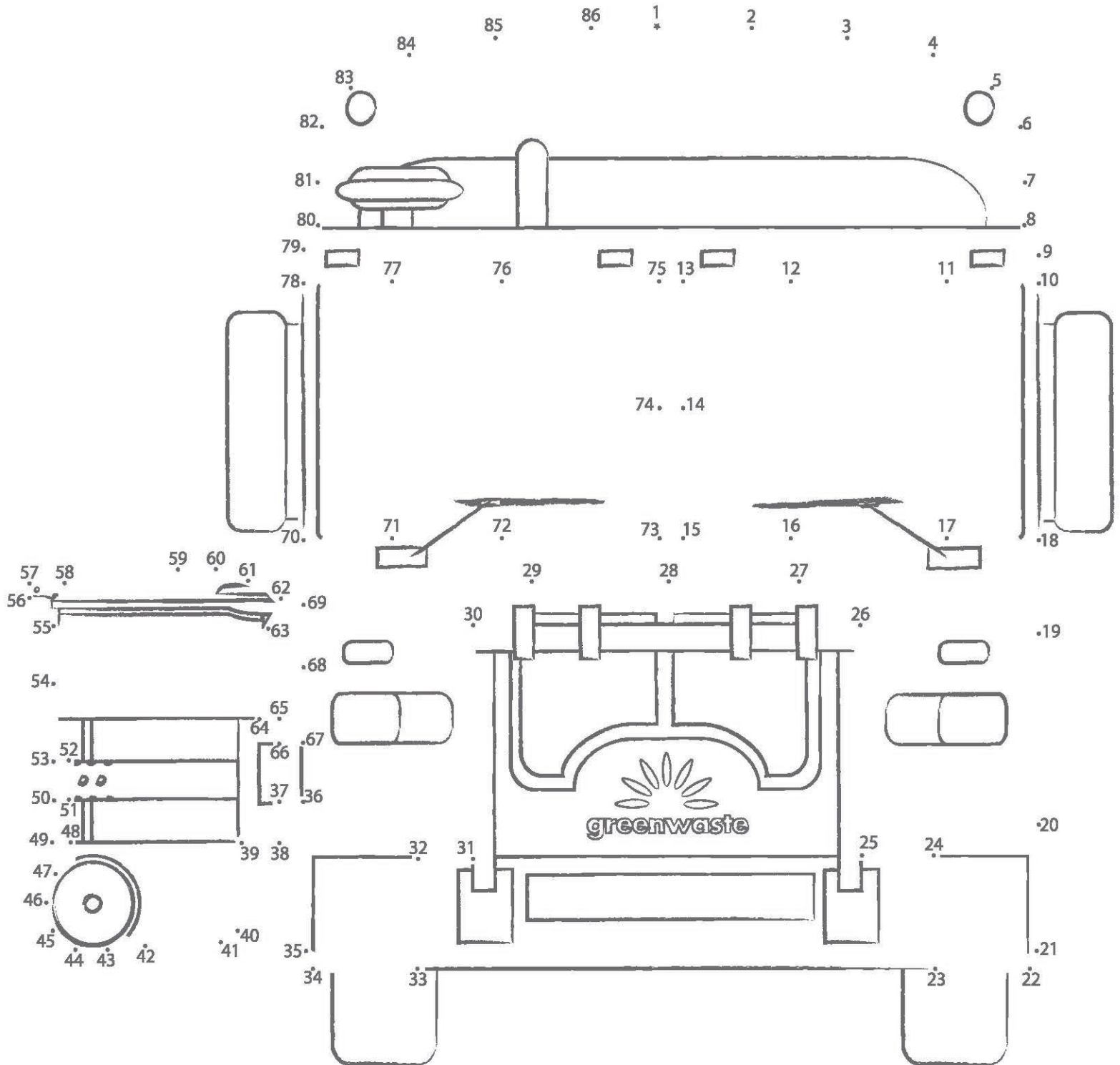

SIDE LOADER TRUCK

REAR LOADER TRUCK



A **rear loader truck** has a big open back where the contents of carts, bins or claw loaders can be dumped.

CLAW LOADER TRACTOR

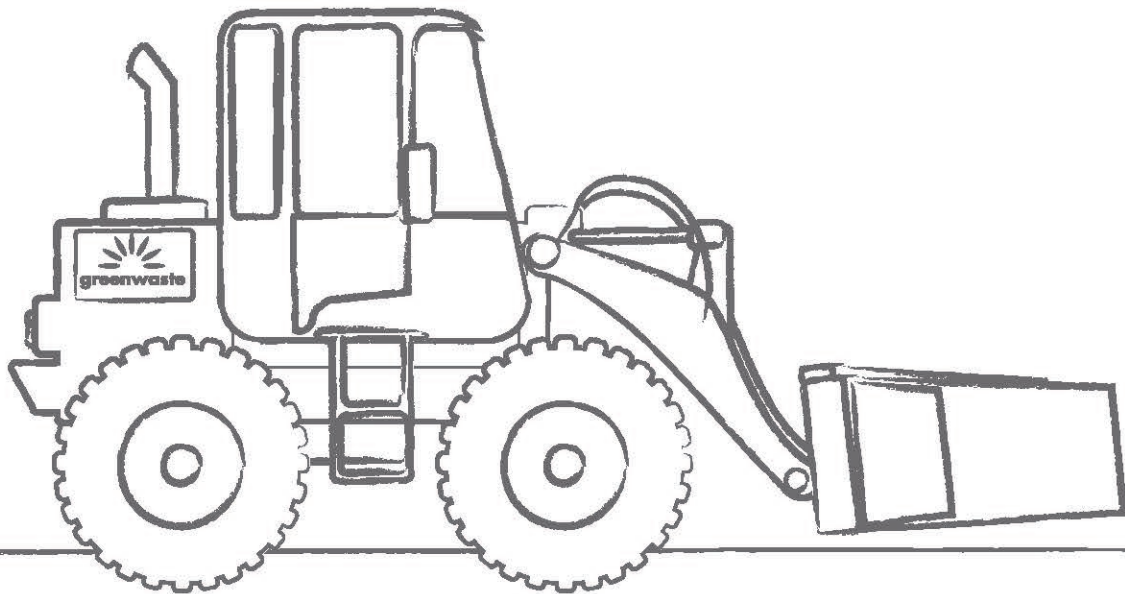

A **claw loader tractor** is a tractor with a pick-up claw to collect piles of yard waste that are set out on the side of the street.

EXCAVATOR

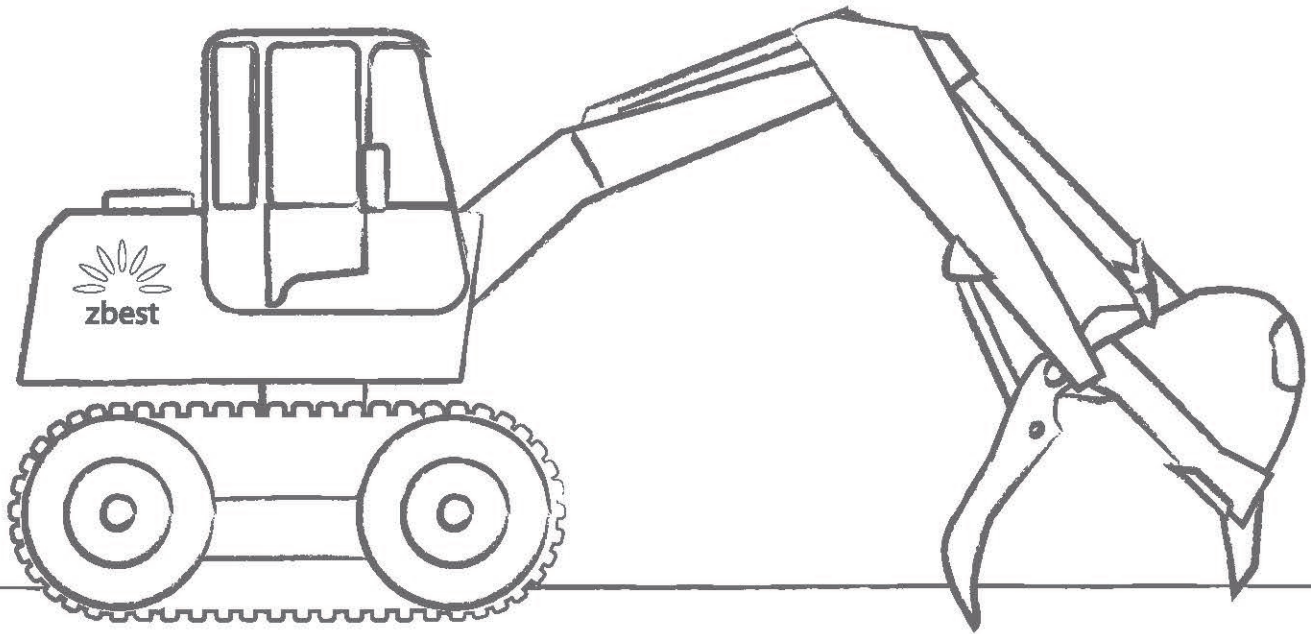

An **excavator** is used to load debris onto a processing conveyor or into a grinder for more sorting before it is put into windrows.

DUMP TRUCK

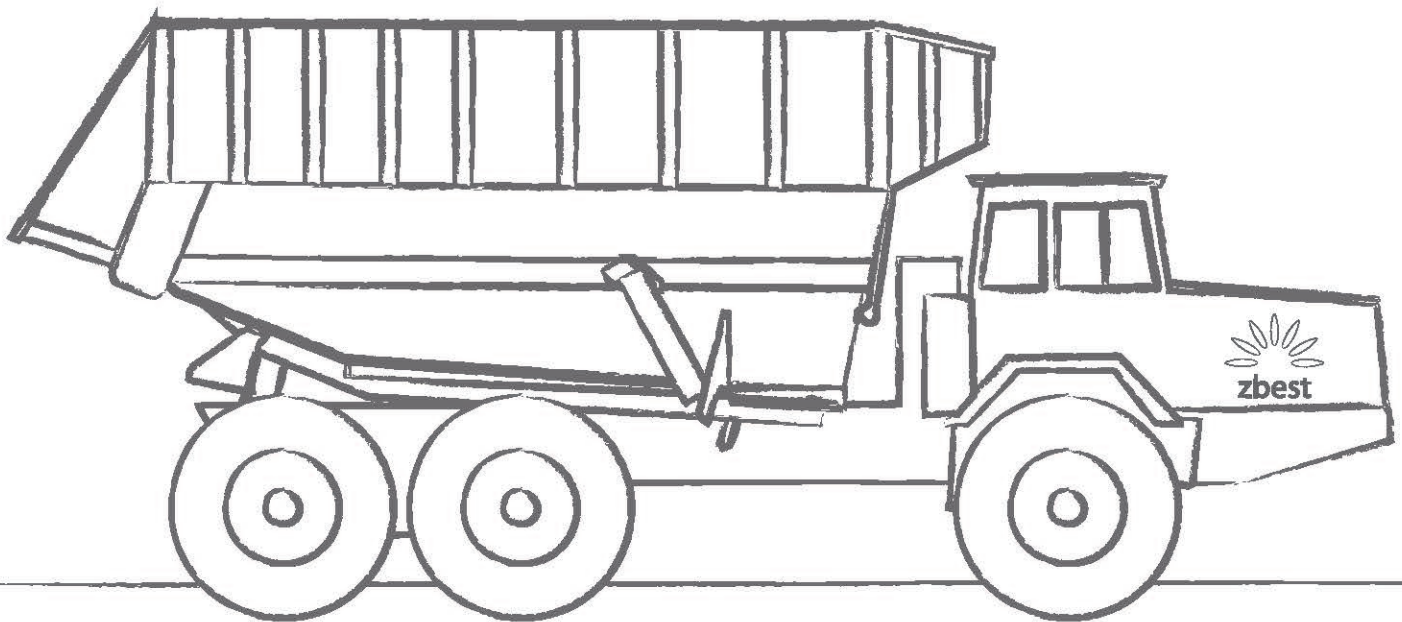

A **dump truck** is used to move ground-up yard waste and leaves from the grinder out to the windrows for composting.

WHAT HAPPENS TO YOUR YARD TRIMMINGS?

STEP 1: They are collected by GreenWaste Recovery and delivered to our Material Recovery Facility (MRF), in San Jose, to be processed into compost.

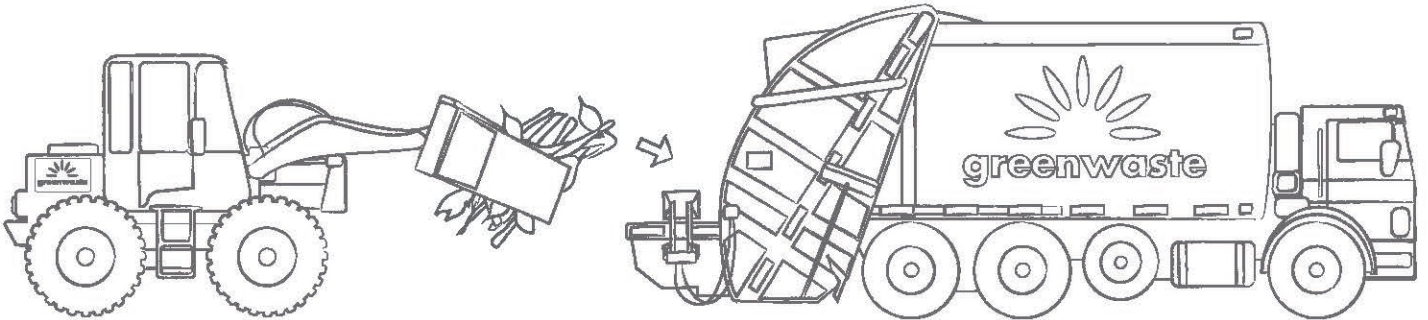

STEP 2: The leaves and branches are ground-up in a large grinder.

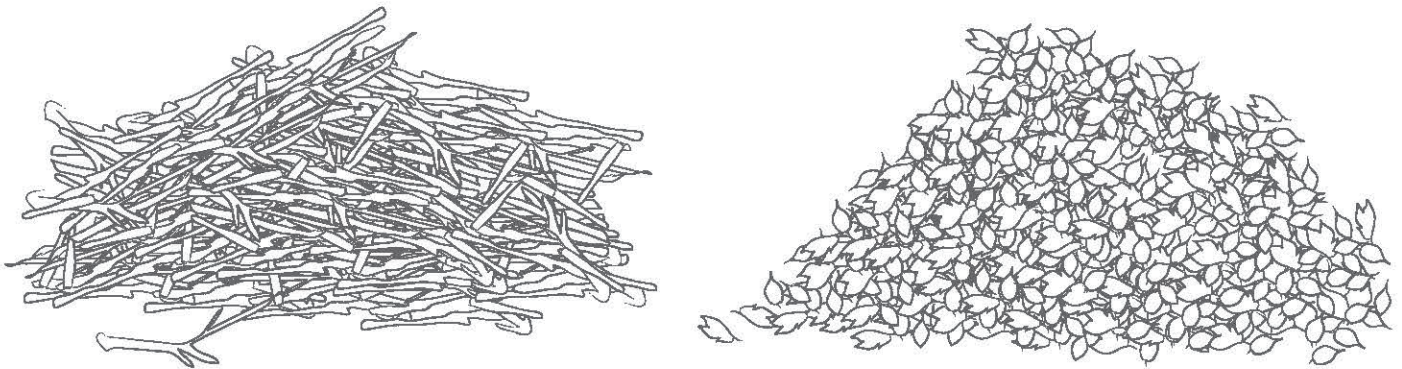

STEP 3: Next, the the ground-up leaves and branches are loaded into a large transfer trailer, then transported to Z-Best Composting Facility in Gilroy, CA.

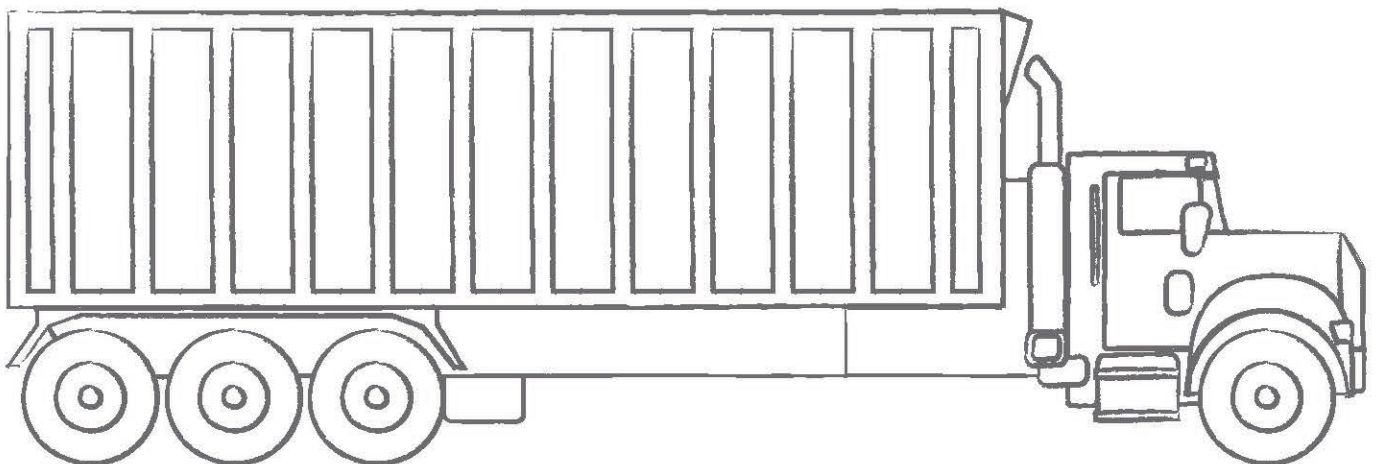

STEP 4: The leaves and branches are put in long piles called windrows. Windrows can be 12 feet tall and 400 feet long, which is longer than a football field!

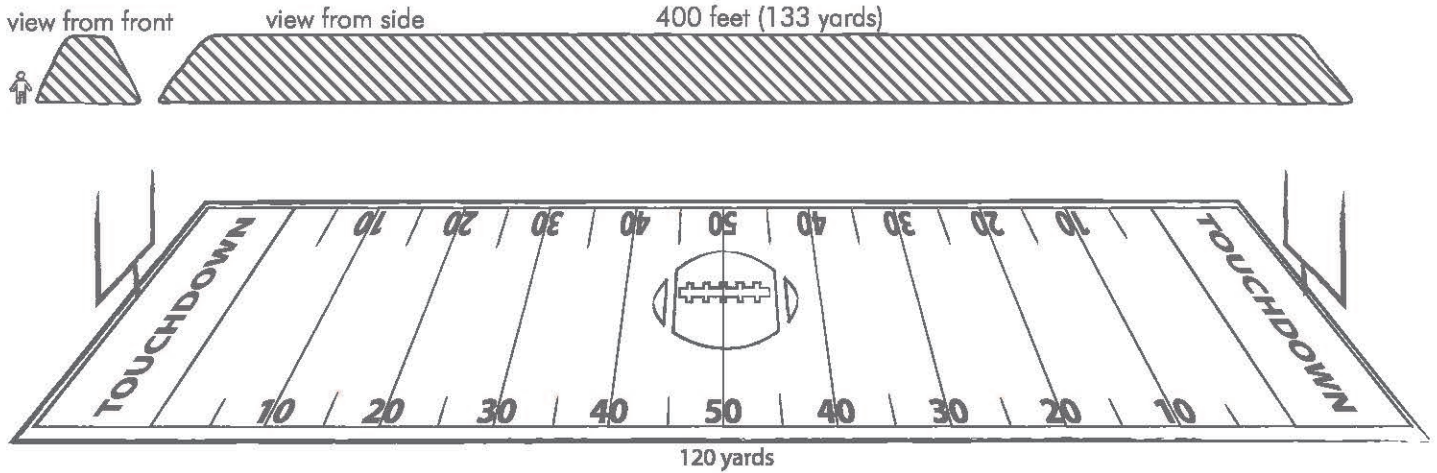

STEP 5: The windrows are turned and mixed regularly and water is added. After 14-16 weeks, the leaves and branches have turned into compost and mulch to be sold to farmers to grow food and to landscapers to be used at houses and businesses.

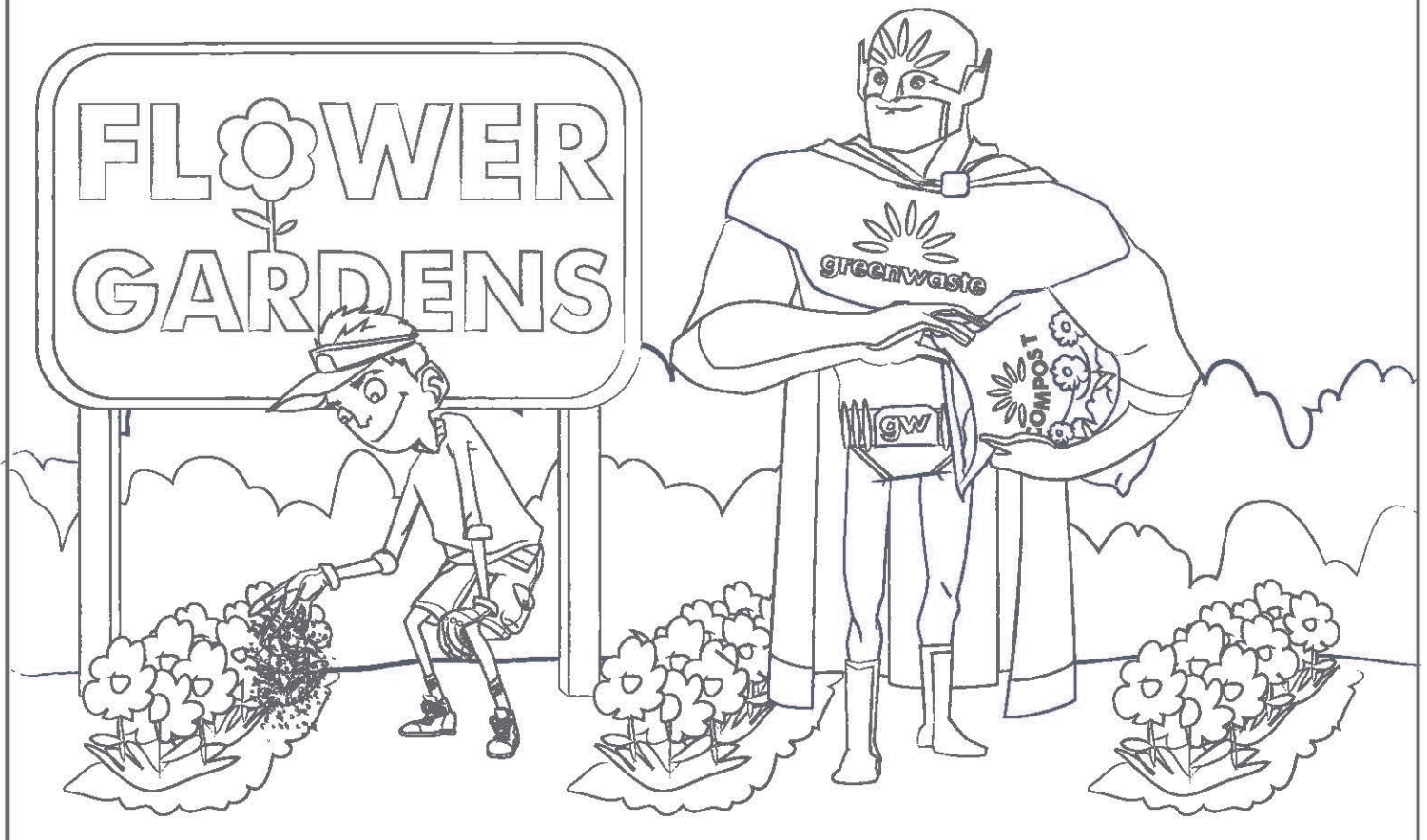

FIND THE HIDDEN WORDS!

Down below is a list of words that are hidden inside the puzzle. All of the words have to do with GreenWaste's operations. To find all 24 words you will have to look across and down. GOOD LUCK!



OFFICIAL CAPTAIN GREENWASTE SIDEKICK CERTIFICATE



greenwaste
a brighter shade of green



RAISE YOUR RIGHT HAND AND
REPEAT AFTER ME.

I _____
your name here

PLEDGE TO DO MY VERY BEST TO SAVE THE
EARTH BY RECYCLING, NOT LITTERING AND
EDUCATING OTHER PEOPLE ON THE REASONS
AND BENEFITS OF CARING ABOUT
THE ONLY PLANET WE HAVE.

BY THE POWER VESTED IN ME
BY GREENWASTE RECOVERY,
I HEREBY NAME YOU A HERO
IN THE EYES OF THE WORLD.



USE YOUR POWERS RESPONSIBLY AND ALWAYS REMEMBER....

REDUCE! REUSE! RECYCLE!

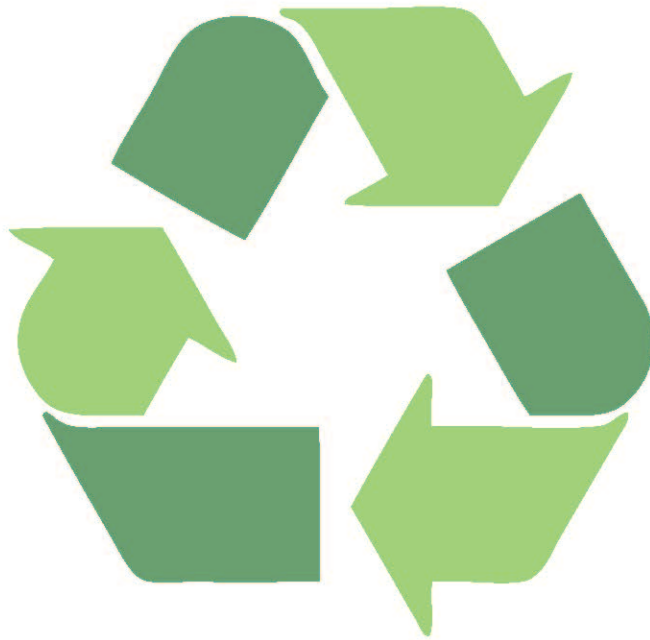

www.greenwaste.com